

Basic Connector Dimensions

Most Popular **Standard** Connectors

**Universal
OSTW and HSTW
"Fits All"**

OSTW

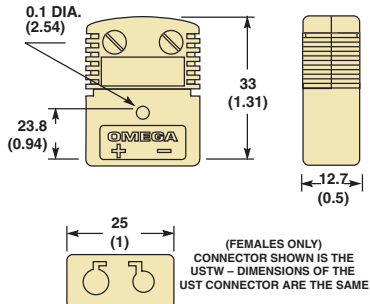

OSTW & HSTW

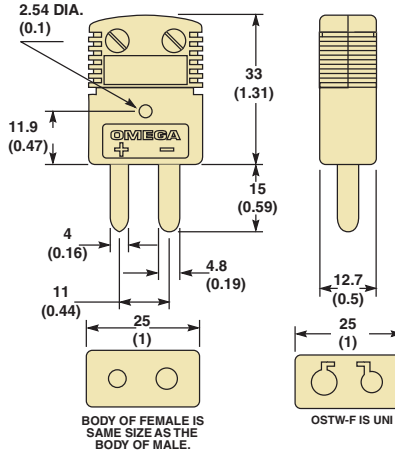

OSTW-CC

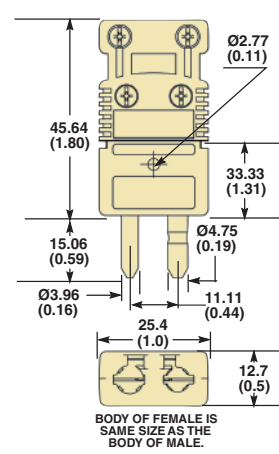

OGP

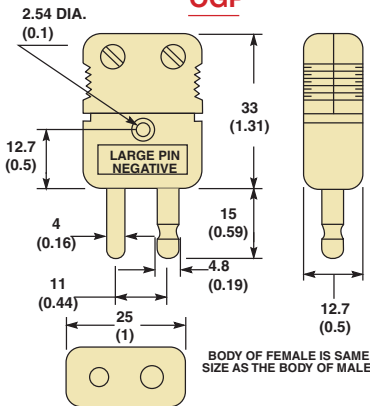

DTC

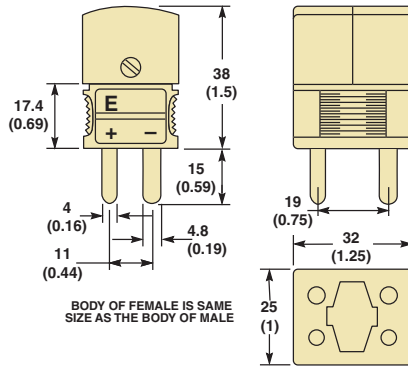

NHX & NHXH

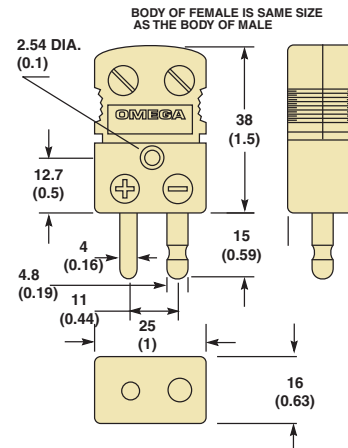

NOX

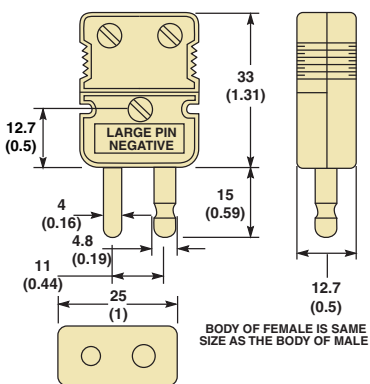

OTP

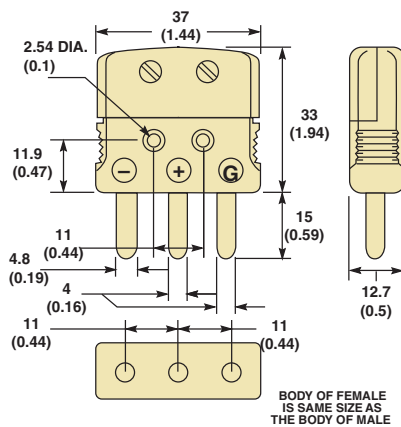

GST (HGST)

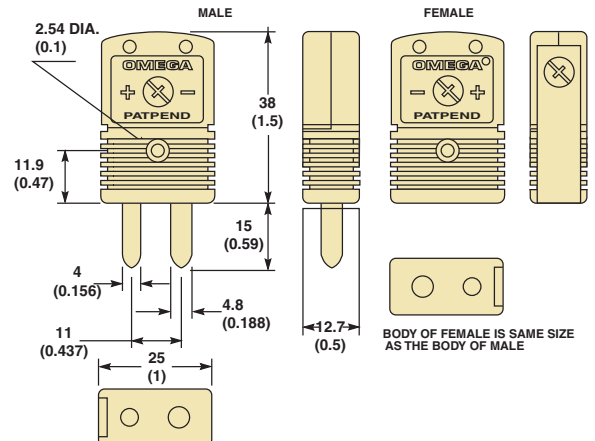

Dimensions: mm (inches)

Basic Connector Dimensions

Most Popular **Miniature** Connectors and Circuit Board Connectors

HMPW, SMPW & SMP

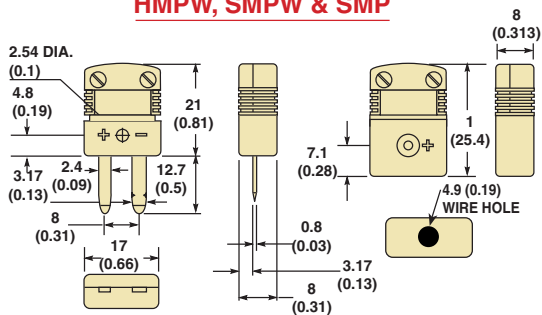

NMP

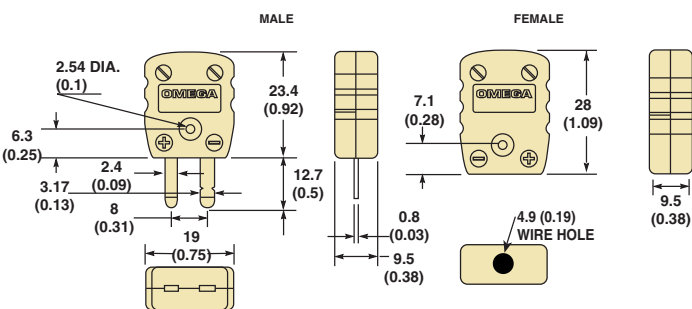

SHX & USHX

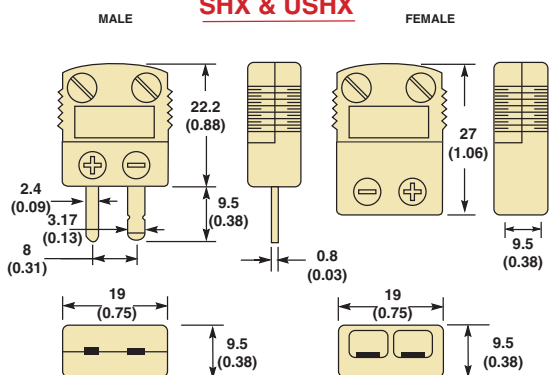

GMP & HGMP

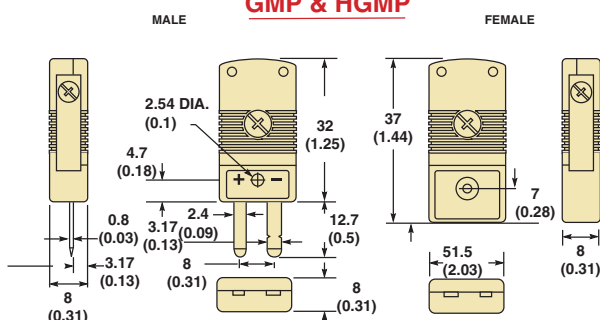

MTP

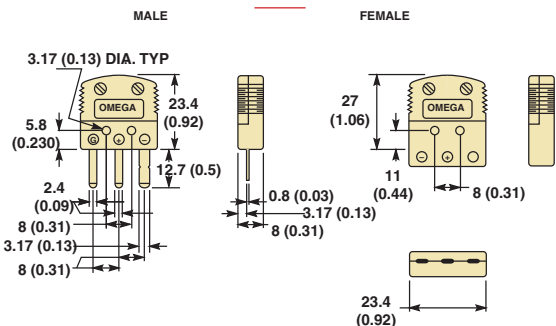

PCC-OST

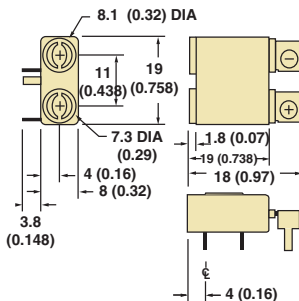

PCC-SMP

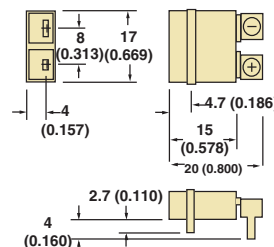

PCC-SMP-V

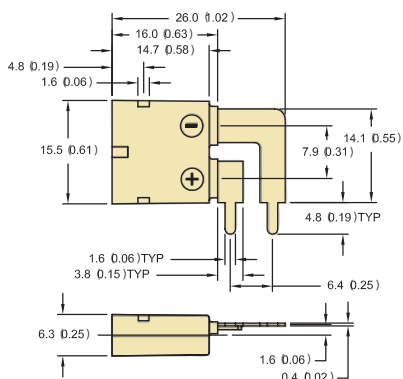

SMPW-CC

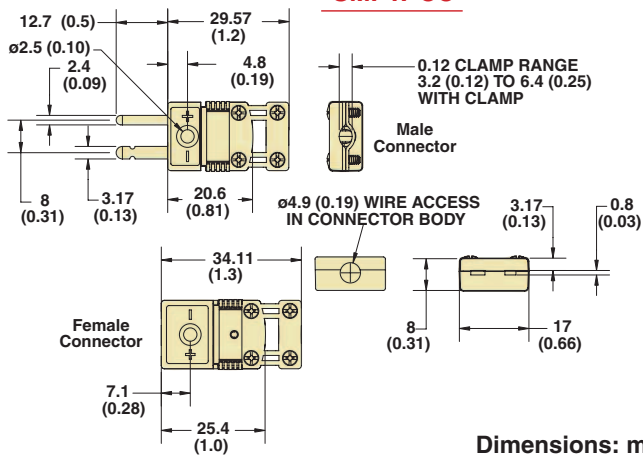

Dimensions: mm (inches)

Basic Connector Dimensions

Most Popular Transition and Panel Connectors

TAS-U-5

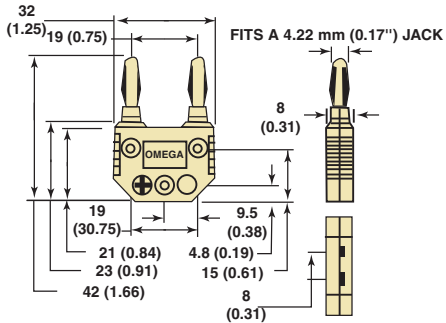

TAS-() ()

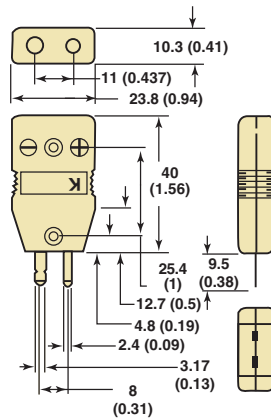

UPJ

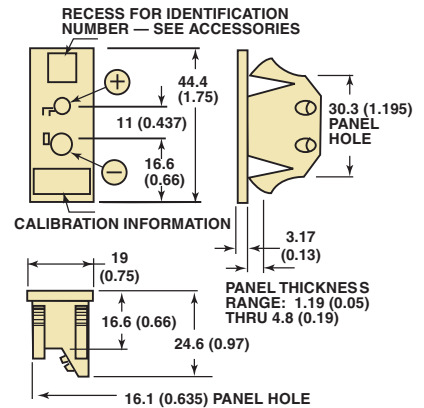

UPF and SPJ

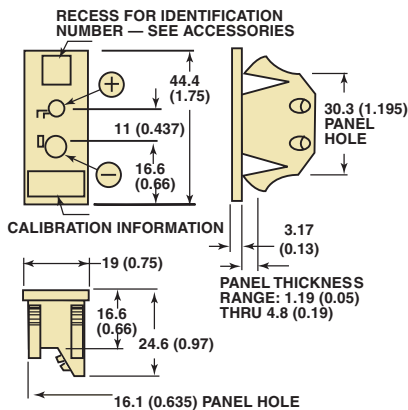

JP

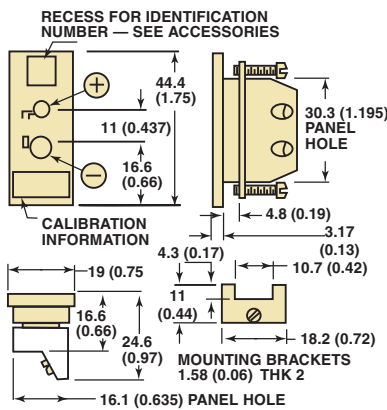

TPJ

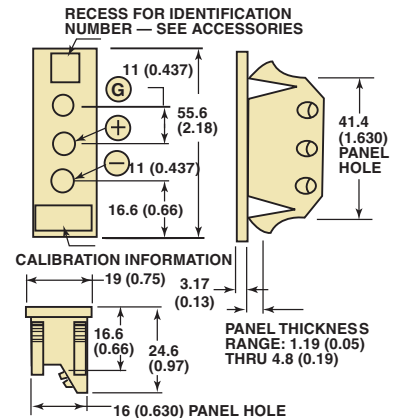

RSJ-() S & R

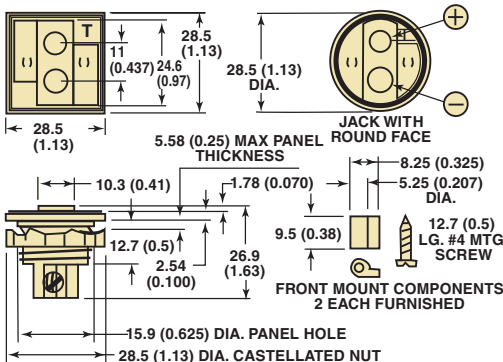

RMJ-S RMJ-R

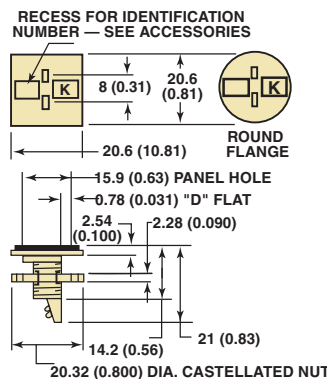

MPJ

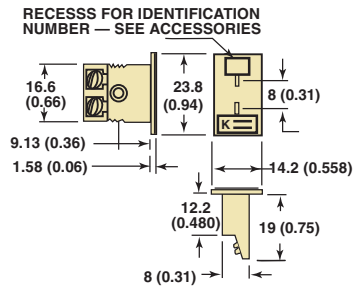

Dimensions: mm (inches)

Basic Connector Dimensions

Most Popular Multipin and Miscellaneous Connectors

MTC () FF

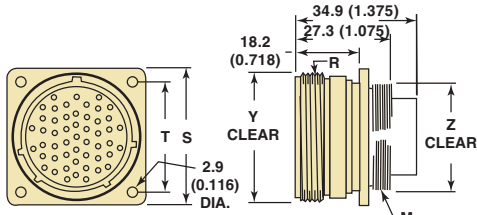

PINS	T	S	Y	Z	M THRD.	R THRD.
5	18.26 (0.72)	23.88 (0.94)	19.05 (0.75)	14.48 (0.57)	0.562-24 UNEF	0.687-24
12	20.62 (0.81)	26.16 (1.03)	23.11 (0.91)	19.30 (0.76)	0.750-20 UNEF	0.875-20
24	24.61 (0.97)	31.75 (1.25)	28.19 (1.11)	24.13 (0.95)	0.937-20 UNEF	1.062-18
41	29.36 (1.16)	36.58 (1.44)	33.78 (1.33)	30.48 (1.20)	1.187-18 UNEF	1.312-18
55	31.75 (1.25)	39.62 (1.56)	36.83 (1.45)	33.53 (1.32)	1.312-18 UNEF	1.437-18

FC & MC

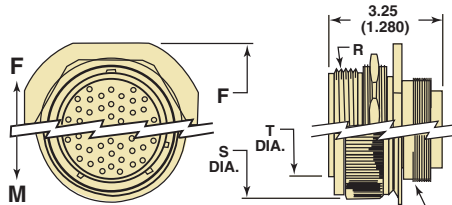

PINS	S	T	F	M THRD.	R THRD.
5	21.08 (0.83)	13.46 (0.53)	27.67 (1.09)	0.562-24	0.687-24
12	25.15 (0.99)	17.78 (0.70)	32.77 (1.29)	0.750-20	0.875-20
24	30.23 (1.19)	22.61 (0.89)	38.61 (1.52)	0.937-20	1.062-18
41	36.07 (1.42)	28.45 (1.12)	45.97 (1.81)	1.187-18	1.312-18
55	39.37 (1.55)	31.75 (1.25)	49.53 (1.95)	1.312-18	1.437-18

MTC

MSP

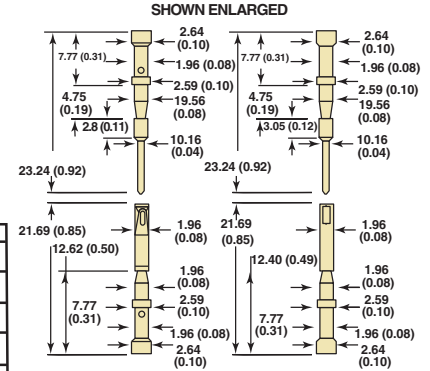

SMTC

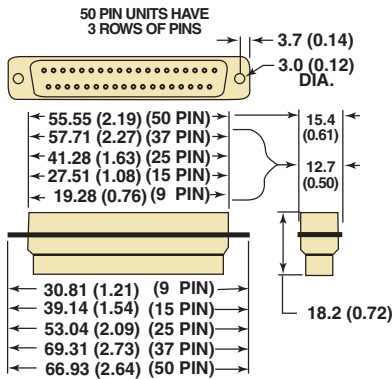

SMTC PINS

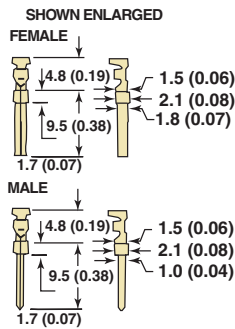

TA () F

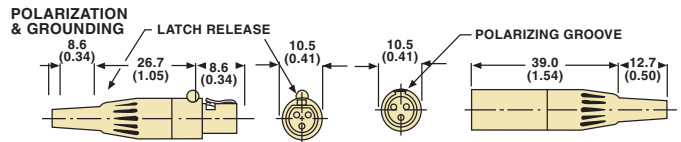

TA () M

TA () FL

TA () ML



ALL DIMENSIONS SAME AS SHOWN ABOVE

BS

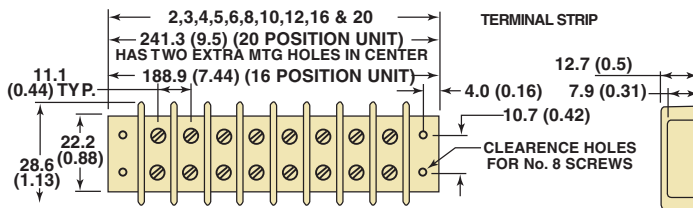

TL

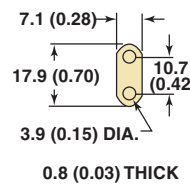

SL

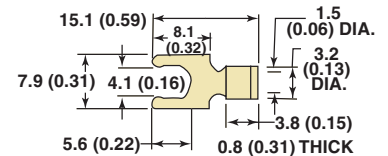

TY

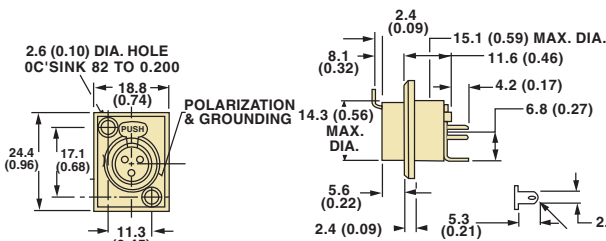

TB

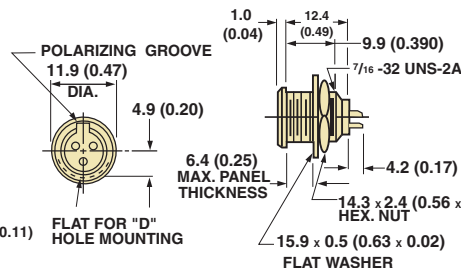

CH6 ()

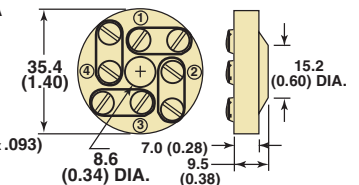

Dimensions: mm (inches)



UNITED STATES

www.omega.com
1-800-TC-OMEGA
Stamford, CT.

CANADA

www.omega.ca
Laval(Quebec)
1-800-TC-OMEGA

GERMANY

www.omega.de
Deckenpfronn, Germany
0800-8266342

UNITED KINGDOM

www.omega.co.uk
Manchester, England
0800-488-488

FRANCE

www.omega.fr
Guyancourt, France
088-466-342

CZECH REPUBLIC

www.omegaeng.cz
Karviná, Czech Republic
596-311-899

BENELUX

www.omega.nl
Amstelveen, NL
0800-099-33-44



More than 100,000 Products Available!

• Temperature

Calibrators, Connectors, General Test and Measurement Instruments, Glass Bulb Thermometers, Handheld Instruments for Temperature Measurement, Ice Point References, Indicating Labels, Crayons, Cements and Lacquers, Infrared Temperature Measurement Instruments, Recorders Relative Humidity Measurement Instruments, RTD Probes, Elements and Assemblies, Temperature & Process Meters, Timers and Counters, Temperature and Process Controllers and Power Switching Devices, Thermistor Elements, Probes and Assemblies, Thermocouples Thermowells and Head and Well Assemblies, Transmitters, Wire

• Flow and Level

Air Velocity Indicators, Doppler Flowmeters, Level Measurement, Magnetic Flowmeters, Mass Flowmeters, Pitot Tubes, Pumps, Rotameters, Turbine and Paddle Wheel Flowmeters, Ultrasonic Flowmeters, Valves, Variable Area Flowmeters, Vortex Shedding Flowmeters

• pH and Conductivity

Conductivity Instrumentation, Dissolved Oxygen Instrumentation, Environmental Instrumentation, pH Electrodes and Instruments, Water and Soil Analysis Instrumentation

• Data Acquisition

Auto-Dialers and Alarm Monitoring Systems, Communication Products and Converters, Data Acquisition and Analysis Software, Data Loggers Plug-in Cards, Signal Conditioners, USB, RS232, RS485 and Parallel Port Data Acquisition Systems, Wireless Transmitters and Receivers

• Pressure, Strain and Force

Displacement Transducers, Dynamic Measurement Force Sensors, Instrumentation for Pressure and Strain Measurements, Load Cells, Pressure Gauges, Pressure Reference Section, Pressure Switches, Pressure Transducers, Proximity Transducers, Regulators, Strain Gages, Torque Transducers, Valves

• Heaters

Band Heaters, Cartridge Heaters, Circulation Heaters, Comfort Heaters, Controllers, Meters and Switching Devices, Flexible Heaters, General Test and Measurement Instruments, Heater Hook-up Wire, Heating Cable Systems, Immersion Heaters, Process Air and Duct, Heaters, Radiant Heaters, Strip Heaters, Tubular Heaters